

**FAMOUS
TOLEDO**

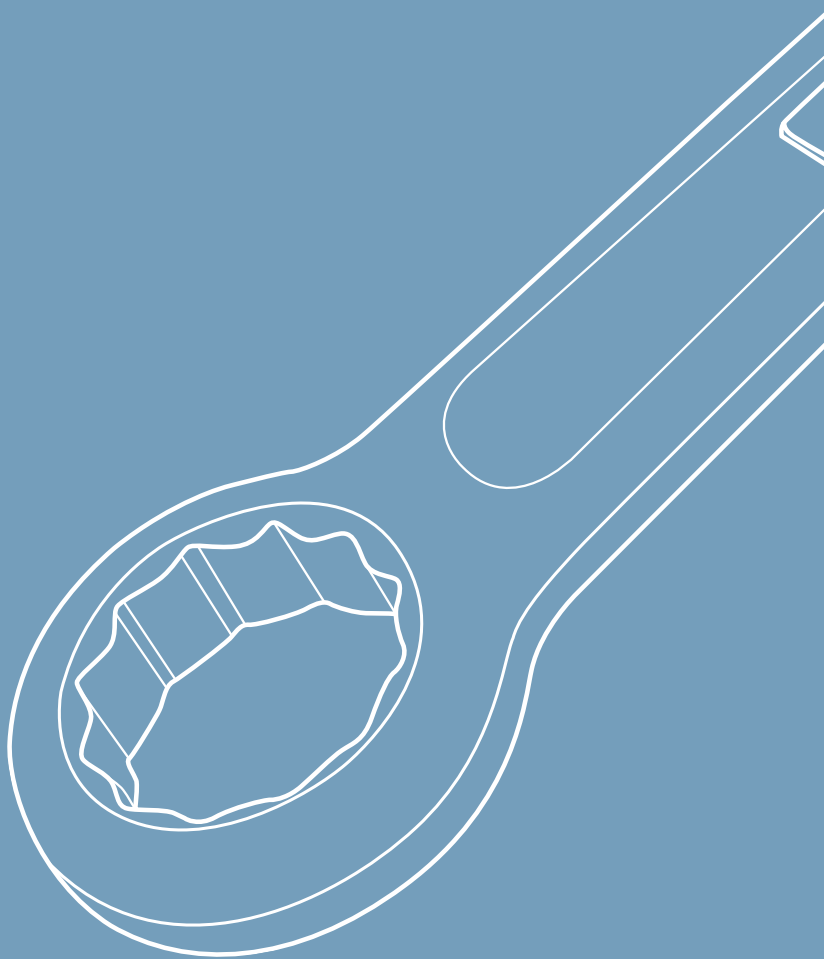

Podgers

Podger Accessories

Slogging Wrenches

SLOGGERS & PODGERS



PODGERS & SLOGGERS

PODGERS

- Toledo podgers are designed and manufactured specifically for heavy duty and industrial use where extra leverage, size and strength is required
- Featuring a tapered end design for easy bolt hole alignment and either a ring, ratchet or dual drive opposing end
- Precisely machined to ensure production accuracy which maximises strength and safety during use

Ratchet Podgers Metric

- Dual sized ratcheting socket – two sizes in one
- Reliable in-built reverse ratcheting lever function for easy direction change
- Ideal for use in applications with confined space
- Manufactured from premium quality drop forged chrome vanadium steel

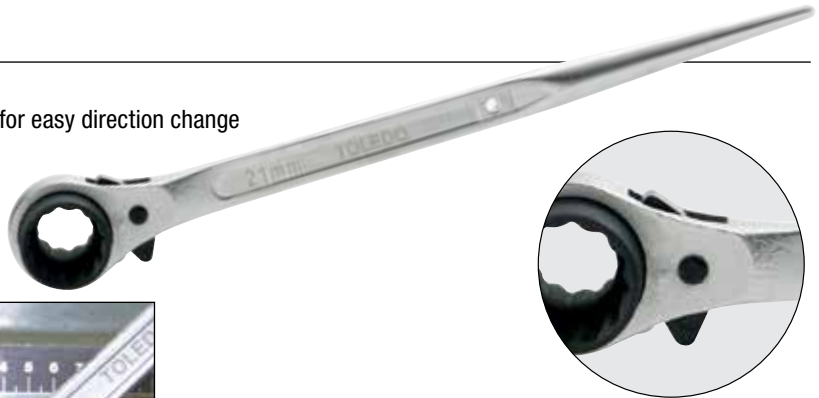

In-built ratchet reverse direction lever.



Ratchet podgers: Aligns bolt holes easily.

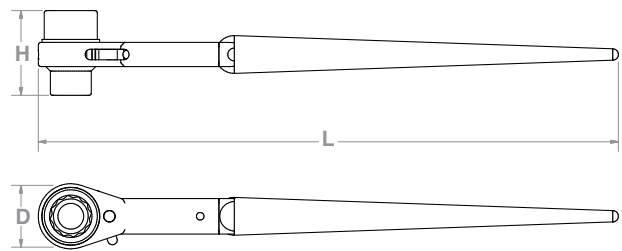

Part No.	Size	Depth (D)	Length (L)	Height (H)	Weight
301223	10 x 12mm	31mm	240mm	37.5mm	200g
301224	13 x 17mm	34mm	280mm	45mm	230g
301225	14 x 15mm	34mm	280mm	45mm	230g
301226	16 x 18mm	42mm	315mm	50mm	450g
301227	17 x 19mm	42mm	315mm	50mm	450g
301228	18 x 24mm	42mm	315mm	50mm	450g
301229	19 x 21mm	42mm	315mm	50mm	450g
301230	19 x 24mm	42mm	315mm	50mm	450g
301231	21 x 24mm	42mm	315mm	50mm	450g
301232	21 x 26mm	52mm	360mm	56mm	800g
301633	22 x 23mm	42mm	315mm	50mm	450g
301233	22 x 24mm	52mm	360mm	56mm	800g
301235	24 x 27mm	52mm	360mm	56mm	800g
301234	24 x 30mm	65mm	450mm	63mm	1250g
301244	26 x 32mm	65mm	450mm	63mm	1250g
301236	27 x 32mm	65mm	450mm	63mm	1250g
301237	30 x 32mm	65mm	450mm	63mm	1250g
301238	32 x 36mm	65mm	450mm	67mm	1250g
321016	34 x 36mm	65mm	450mm	67mm	1250g
301239	36 x 41mm	65mm	450mm	67mm	1250g
301240	41 x 46mm	88mm	500mm	74mm	2300g
301241	41 x 55mm	88mm	500mm	74mm	2300g
301242	46 x 50mm	88mm	500mm	74mm	2300g



Ratchet Podger Scaffolders, Metric

- Uniquely designed option specifically for scaffolding applications
- Dual sized ratcheting socket 21 x 24mm – two sizes in one
- Reliable in-built reverse ratcheting lever function for easy direction change
- Manufactured from premium quality drop forged chrome vanadium steel
- Overall length: 240mm



Ratchet podgers: For extra leverage on fasteners in confined spaces.

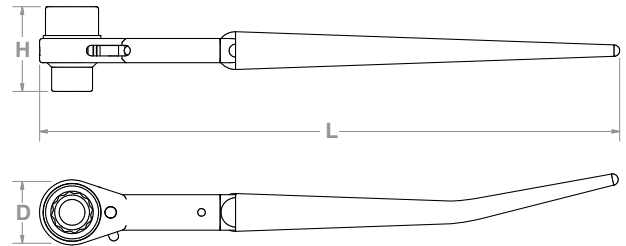

Part No.	Size	Depth (D)	Length (L)	Height (H)	Weight
301243	21 x 24mm	31mm	240mm	37.5mm	200g

Dual Drive Podgers

- Dual square drive heads
- Designed for scaffolding and steel work applications
- Heavy duty 32 tooth ratchet mechanism
- Features stress relief drive on all socket heads
- Manufactured from chrome vanadium steel with black oxide finish for additional corrosion resistance and durability



Two square drives in one ratcheting podger.

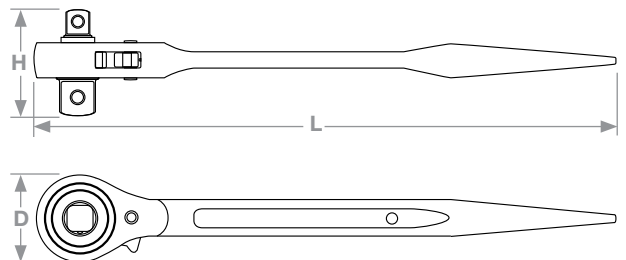

Part No.	Square Drive	Depth (D)	Length (L)	Height (H)	Weight
321020	1/4" x 3/8"	34mm	280mm	35mm	300g
321021	3/8" x 1/2"	42mm	315mm	47mm	500g
321022	1/2" x 3/4"	52mm	360mm	64mm	900g
321023	3/4" x 1"	55mm	450mm	71mm	1500g

PODGERS & SLOGGERS

Ring Podgers SAE

- Manufactured from premium quality drop-forged chrome molybdenum steel
- Conform to ISO 9001:2000 quality standards

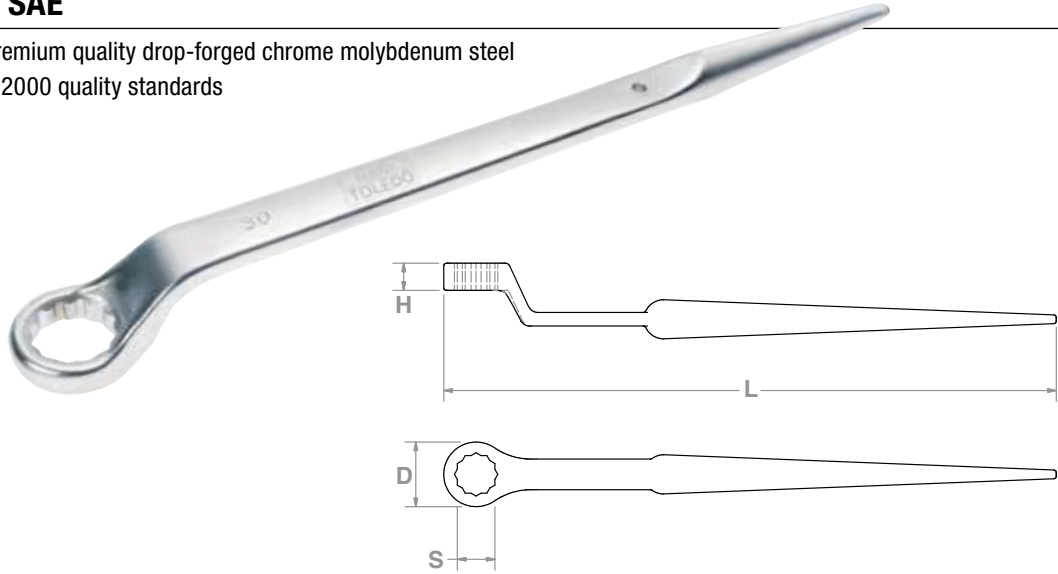

Where extra leverage on tough fasteners is required. Aligns bolt holes easily.

Part No.	Size (S)	Depth (D)	Length (L)	Height (H)	Weight
RP687	1 ¹ / ₁₆ "	28mm	324mm	10.4mm	340g
RP750	3/4"	28mm	324mm	10.4mm	340g
RP812	13/16"	36mm	368mm	12.4mm	542g
RP875	7/8"	36mm	368mm	12.4mm	542g
RP937	15/16"	40mm	380mm	12.9mm	678g
RP1000	1"	40mm	380mm	12.9mm	678g
RP1062	1 ¹ / ₁₆ "	47mm	393mm	13.4mm	762g
RP1125	1 ¹ / ₈ "	47mm	393mm	13.4mm	762g
RP1250	1 ¹ / ₄ "	50mm	409mm	14.9mm	870g
RP1312	15/16"	50mm	409mm	14.9mm	870g
RP1437	17/16"	57mm	465mm	16.7mm	1422g
RP1500	1 ¹ / ₂ "	62.5mm	490mm	18.3mm	1676g
RP1625	15/8"	62.5mm	490mm	18.3mm	1676g
RP1687	11 ¹ / ₁₆ "	62.5mm	490mm	18.3mm	1676g
RP1750	13/4"	68mm	519mm	19.9mm	2030g
RP1812	113/16"	68mm	519mm	19.9mm	2030g
RP1875	17/8"	78mm	594mm	24.4mm	3100g
RP2000	2"	78mm	594mm	24.4mm	3200g
RP2062	21/16"	78mm	594mm	24.4mm	3200g
RP2187	23/16"	92mm	616mm	29mm	4860g
RP2250	21/4"	92mm	616mm	29mm	4860g
RP2375	23/8"	92mm	616mm	29mm	4860g



Ring Podgers Metric

- Manufactured from premium quality drop-forged chrome molybdenum steel
- Conform to ISO 9001:2000 quality standards

Part No.	Size (S)	Depth (D)	Length (L)	Height (H)	Weight
RPM17	17mm	28mm	324mm	10.4mm	340g
RPM19	19mm	28mm	324mm	10.4mm	340g
RPM22	22mm	36mm	368mm	12.4mm	542g
RPM24	24mm	40mm	380mm	12.9mm	678g
RPM27	27mm	47mm	393mm	13.4mm	762g
RPM30	30mm	50mm	409mm	14.9mm	870g
RPM32	32mm	50mm	409mm	14.9mm	870g
RPM36	36mm	57mm	465mm	16.7mm	1422g
RPM41	41mm	62.5mm	490mm	18.3mm	1676g
RPM46	46mm	68mm	519mm	19.9mm	2030g
RPM50	50mm	78mm	594mm	24.4mm	3200g
RPM55	55mm	78mm	594mm	24.4mm	3200g
RPM60	60mm	92mm	616mm	29mm	4860g

PODGER ACCESSORIES

Security Spring Hooks

- Designed for securing tools when working at high levels such as roofs, scaffolding etc, to prevent loss of tools and downtime retrieving fallen tools
- Stainless steel wire, PU Coated
- Spring hooks attach to belt and tool to prevent tools from falling if dropped
- Available in 5kg and 10kg rated strength
- Supplied with small wire and ring to attach tool to body or fixing point



5kg
Load weight
Part No. 301907

10kg
Load weight
Part No. 301908

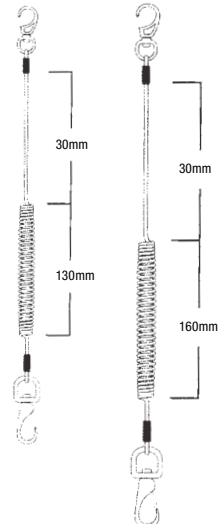

Part No.	Load Weight	Working Length	Maximum Extension
301907	5kg	430mm	1400mm
301908	10kg	600mm	1800mm

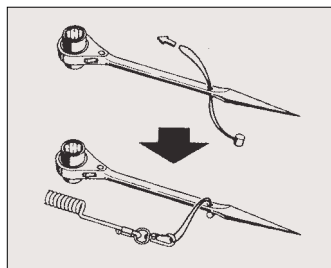
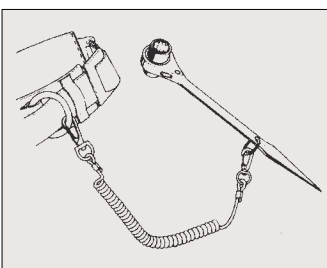

SLOGING WRENCHES

- Suitable for various applications such as ship maintenance, mining, piping and industrial applications where extra force is required to tighten or loosen large nuts, bolts and other fasteners
- One end features a socket or open ended wrench to fit the fastener and the other is enlarged to receive striking from a hammer etc.
- The shock of the striking impact is useful in cracking stubborn fasteners or tightening newly applied fasteners
- Toledo sloggers are recognised as the premium quality option on the Australian market famous for their strength, longevity, reliability and safety
- Each slogging wrench is individually reviewed and checked to ensure quality
- Available in flat or cranked style in both metric and SAE sizes
- Toledo sloggers conform to ISO 9001:2000 quality standards



When using any slogging wrench always wear protective eye and head wear

Flat Slogging Wrenches Whitworth

- Heavy duty, premium quality



Sloggers: Ideal for loosening large nuts when extra force is required.

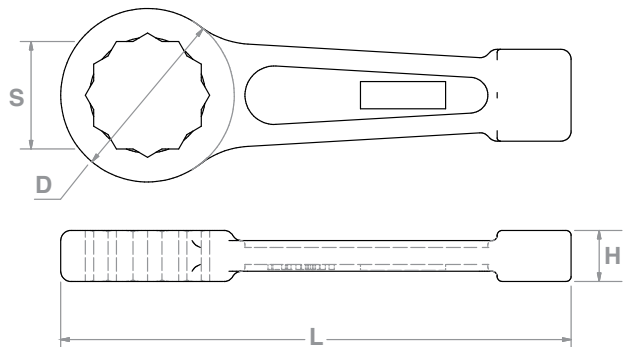

Part No.	Size (S)	Depth (D)	Length (L)	Height (H)	Weight
SWR1200	1 ¹ / ₁₆ " Whitworth	54mm	190mm	17mm	430g
SWR1300	3/4" Whitworth	54mm	190mm	17mm	430g
SWR2580	1 ⁵ / ₈ " Whitworth	66mm	215mm	22mm	800g
SWR3150	2" Whitworth	86mm	270mm	25mm	1800g



Flat Slogging Wrenches SAE

- Heavy duty, premium quality



Sloggers: Ideal for loosening large nuts when extra force is required.

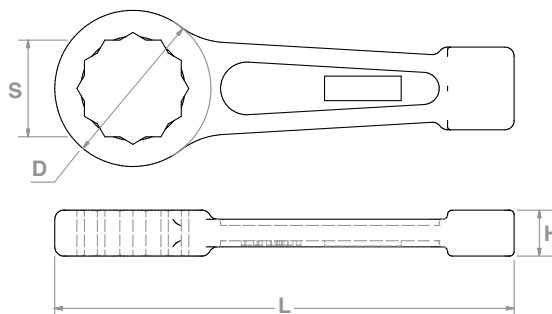

Part No.	Size (S)	Depth (D)	Length (L)	Height (H)	Weight
SWR1062	1 ¹ / ₁₆ "	47mm	185mm	17mm	390g
SWR1125	1 ¹ / ₈ "	54mm	190mm	17mm	430g
SWR1187	1 ³ / ₁₆ "	54mm	190mm	17mm	430g
SWR1250	1 ¹ / ₄ "	54mm	190mm	17mm	430g
SWR1312	1 ⁵ / ₁₆ "	54mm	190mm	17mm	430g
SWR1375	1 ³ / ₈ "	60mm	190mm	17mm	650g
SWR1437	1 ⁷ / ₁₆ "	66mm	215mm	22mm	800g
SWR1500	1 ¹ / ₂ "	66mm	215mm	22mm	800g
SWR1562	1 ⁹ / ₁₆ "	66mm	215mm	22mm	800g
SWR1625	1 ⁵ / ₈ "	66mm	215mm	22mm	800g
SWR1687	1 ¹¹ / ₁₆ "	74mm	240mm	23mm	1000g
SWR1750	1 ³ / ₄ "	74mm	240mm	23mm	1000g
SWR1812	1 ¹³ / ₁₆ "	74mm	240mm	23mm	1000g
SWR1875	1 ⁷ / ₈ "	74mm	240mm	23mm	1000g
SWR2000	2"	86mm	270mm	25mm	1800g
SWR2062	2 ¹ / ₁₆ "	86mm	270mm	25mm	1800g
SWR2125	2 ¹ / ₈ "	86mm	270mm	25mm	1800g
SWR2187	2 ³ / ₁₆ "	94mm	270mm	25mm	1800g
SWR2250	2 ¹ / ₄ "	94mm	270mm	25mm	1800g
SWR2312	2 ⁵ / ₁₆ "	94mm	270mm	25mm	1800g
SWR2375	2 ³ / ₈ "	102mm	300mm	30mm	2500g
SWR2437	2 ⁷ / ₁₆ "	102mm	300mm	30mm	2500g
SWR2500	2 ¹ / ₂ "	102mm	300mm	30mm	2500g
SWR2562	2 ⁹ / ₁₆ "	102mm	300mm	30mm	2500g
SWR2625	2 ⁵ / ₈ "	102mm	300mm	30mm	2500g
SWR2750	2 ³ / ₄ "	115mm	330mm	33mm	3400g
SWR2875	2 ⁷ / ₈ "	115mm	330mm	33mm	3400g
SWR2937	2 ¹⁵ / ₁₆ "	115mm	330mm	33mm	3400g
SWR3000	3"	115mm	330mm	33mm	3400g
SWR3125	3 ¹ / ₈ "	125mm	360mm	36mm	3900g
SWR3875	3 ⁷ / ₈ "	155mm	420mm	45mm	7000g

Flat Slogging Wrenches Metric

- Heavy duty, premium quality

Part No.	Size (S)	Depth (D)	Length (L)	Height (H)	Weight
SWRM24	24mm	47mm	185mm	17mm	390g
SWRM27	27mm	47mm	185mm	17mm	390g
SWRM30	30mm	54mm	190mm	17mm	430g
SWRM32	32mm	54mm	190mm	17mm	430g
SWRM36	36mm	60mm	190mm	17mm	650g
SWRM41	41mm	66mm	215mm	22mm	800g
SWRM46	46mm	74mm	240mm	23mm	1000g
SWRM50	50mm	74mm	240mm	23mm	1000g
SWRM55	55mm	86mm	270mm	25mm	1800g
SWRM60	60mm	94mm	270mm	25mm	1800g
SWRM65	65mm	102mm	300mm	30mm	2500g
SWRM70	70mm	115mm	330mm	33mm	3400g
SWRM75	75mm	115mm	330mm	33mm	3400g
SWRM80	80mm	125mm	360mm	36mm	3900g
SWRM85	85mm	125mm	360mm	36mm	3900g
SWRM90	90mm	142mm	390mm	40mm	3900g
SWRM95	95mm	142mm	390mm	40mm	3900g
SWRM100	100mm	155mm	420mm	45mm	6100g

Offset/Cranked Slogging Wrenches Metric

- Heavy duty, premium quality
- Offset head at 50°

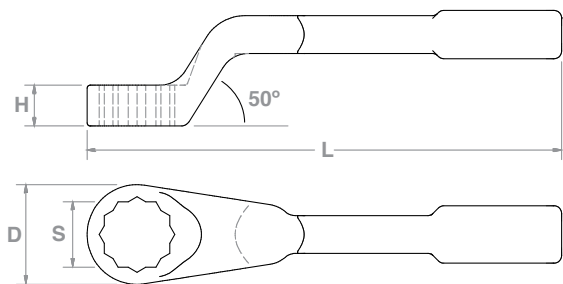

Part No.	Size (S)	Depth (D)	Length (L)	Height (H)	Weight
SWRM24/C	24mm	52mm	304mm	21mm	1980g
SWRM27/C	27mm	52mm	304mm	21mm	1980g
SWRM30/C	30mm	52mm	304mm	21mm	1980g
SWRM32/C	32mm	52mm	304mm	21mm	1980g
SWRM36/C	36mm	52mm	304mm	21mm	1980g
SWRM41/C	41mm	66mm	314mm	27mm	2400g
SWRM46/C	46mm	66mm	314mm	27mm	2400g
SWRM50/C	50mm	78mm	378mm	32mm	3950g
SWRM55/C	55mm	78mm	378mm	32mm	3950g
SWRM60/C	60mm	110mm	406mm	42mm	5930g
SWRM65/C	65mm	110mm	406mm	42mm	5930g
SWRM70/C	70mm	110mm	406mm	42mm	5930g
SWRM75/C	75mm	110mm	406mm	42mm	5930g



Offset/Cranked Slogging Wrenches SAE

- Heavy duty, premium quality
- Offset head at 50°

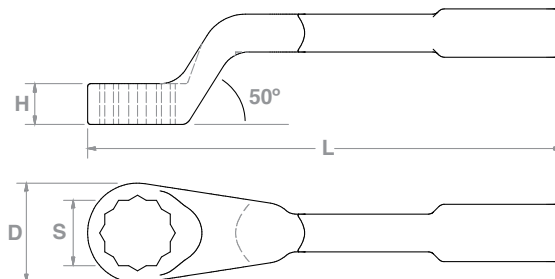

Part No.	Size (S)	Depth (D)	Length (L)	Height (H)	Weight
SWR1062/C	1 ¹ / ₁₆ "	52mm	304mm	21mm	1980g
SWR1125/C	1 ¹ / ₈ "	52mm	304mm	21mm	1980g
SWR1187/C	1 ³ / ₁₆ "	52mm	304mm	21mm	1980g
SWR1250/C	1 ¹ / ₄ "	52mm	304mm	21mm	1980g
SWR1312/C	1 ⁵ / ₁₆ "	52mm	304mm	21mm	1980g
SWR1375/C	1 ³ / ₈ "	52mm	304mm	21mm	1980g
SWR1437/C	1 ⁷ / ₁₆ "	52mm	304mm	21mm	1980g
SWR1500/C	1 ¹ / ₂ "	66mm	314mm	27mm	2400g
SWR1562/C	1 ⁹ / ₁₆ "	66mm	314mm	27mm	2400g
SWR1625/C	1 ⁵ / ₈ "	66mm	314mm	27mm	2400g
SWR1687/C	1 ¹¹ / ₁₆ "	66mm	314mm	27mm	2400g
SWR1750/C	1 ³ / ₄ "	66mm	314mm	27mm	2400g
SWR1812/C	1 ¹³ / ₁₆ "	66mm	314mm	27mm	2400g
SWR1875/C	1 ⁷ / ₈ "	78mm	378mm	32mm	3950g
SWR2000/C	2"	78mm	378mm	32mm	3950g
SWR2062/C	2 ¹ / ₁₆ "	78mm	378mm	32mm	3950g
SWR2125/C	2 ¹ / ₈ "	78mm	378mm	32mm	3950g
SWR2187/C	2 ³ / ₁₆ "	78mm	378mm	32mm	3950g
SWR2250/C	2 ¹ / ₄ "	110mm	406mm	42mm	5930g
SWR2312/C	2 ⁵ / ₁₆ "	110mm	406mm	42mm	5930g
SWR2375/C	2 ³ / ₈ "	110mm	406mm	42mm	5930g
SWR2437/C	2 ⁷ / ₁₆ "	110mm	406mm	42mm	5930g
SWR2500/C	2 ¹ / ₂ "	110mm	406mm	42mm	5930g
SWR2562/C	2 ⁹ / ₁₆ "	110mm	406mm	42mm	5930g
SWR2625/C	2 ⁵ / ₈ "	110mm	406mm	42mm	5930g
SWR2750/C	2 ³ / ₄ "	110mm	406mm	42mm	5930g
SWR2875/C	2 ⁷ / ₈ "	110mm	406mm	42mm	5930g
SWR2937/C	2 ¹⁵ / ₁₆ "	110mm	406mm	42mm	5930g
SWR3000/C	3"	110mm	406mm	42mm	5930g
SWR3500/C	3 ¹ / ₂ "	130mm	450mm	55mm	11850g

PODGERS & SLOGGERS

Offset/Cranked Slogging Wrenches Safety Version, SAE

- Additional safety feature via the introduction of a safety handle that neatly slots into a hex hole which has been cut into the top of the bridge of the offset slogging wrench
- The safety handle (one size fits all) features a 1/2" square drive insert and is 400mm long. The purpose of the safety handle is to reduce the chance of injury around the striking area
- The handle offers the user the chance to stabilise the slogger whilst having their hands away from the impact zone. This reduces the chance for injury and gives the user peace of mind



Part No.	Size (S)	Depth (D)	Length (L)	Height (H)	Weight
SWR1062/CS	1 ¹ / ₁₆ "	52mm	304mm	21mm	1970g
SWR1125/CS	1 ¹ / ₈ "	52mm	304mm	21mm	1970g
SWR1187/CS	1 ³ / ₁₆ "	52mm	304mm	21mm	1970g
SWR1250/CS	1 ¹ / ₄ "	52mm	304mm	21mm	1970g
SWR1312/CS	1 ⁵ / ₁₆ "	52mm	304mm	21mm	1970g
SWR1375/CS	1 ³ / ₈ "	52mm	304mm	21mm	1970g
SWR1437/CS	1 ⁷ / ₁₆ "	52mm	304mm	21mm	1970g
SWR1500/CS	1 ¹ / ₂ "	66mm	314mm	27mm	2300g
SWR1562/CS	1 ⁹ / ₁₆ "	66mm	314mm	27mm	2300g
SWR1625/CS	1 ⁵ / ₈ "	66mm	314mm	27mm	2300g
SWR1687/CS	1 ¹¹ / ₁₆ "	66mm	314mm	27mm	2300g
SWR1750/CS	1 ³ / ₄ "	66mm	314mm	27mm	2300g
SWR1812/CS	1 ¹³ / ₁₆ "	66mm	314mm	27mm	2300g
SWR1875/CS	1 ⁷ / ₈ "	78mm	378mm	32mm	3940g
SWR2000/CS	2"	78mm	378mm	32mm	3940g
SWR2062/CS	2 ¹ / ₁₆ "	78mm	378mm	32mm	3940g
SWR2125/CS	2 ¹ / ₈ "	78mm	378mm	32mm	3940g
SWR2187/CS	2 ³ / ₁₆ "	78mm	378mm	32mm	3940g
SWR2250/CS	2 ¹ / ₄ "	110mm	406mm	42mm	5920g
SWR2312/CS	2 ⁵ / ₁₆ "	110mm	406mm	42mm	5920g
SWR2375/CS	2 ³ / ₈ "	110mm	406mm	42mm	5920g
SWR2437/CS	2 ⁷ / ₁₆ "	110mm	406mm	42mm	5920g
SWR2500/CS	2 ¹ / ₂ "	110mm	406mm	42mm	5920g
SWR2562/CS	2 ⁹ / ₁₆ "	110mm	406mm	42mm	5920g
SWR2625/CS	2 ⁵ / ₈ "	110mm	406mm	42mm	5920g
SWR2750/CS	2 ³ / ₄ "	110mm	406mm	42mm	5920g
SWR2875/CS	2 ⁷ / ₈ "	110mm	406mm	42mm	5920g
SWR2937/CS	2 ¹⁵ / ₁₆ "	110mm	406mm	42mm	5920g
SWR3000/CS	3"	110mm	406mm	42mm	5920g
SWR3500/CS	3 ¹ / ₂ "	130mm	450mm	55mm	11840g



Offset/Cranked Slogging Wrenches Safety Version, Metric

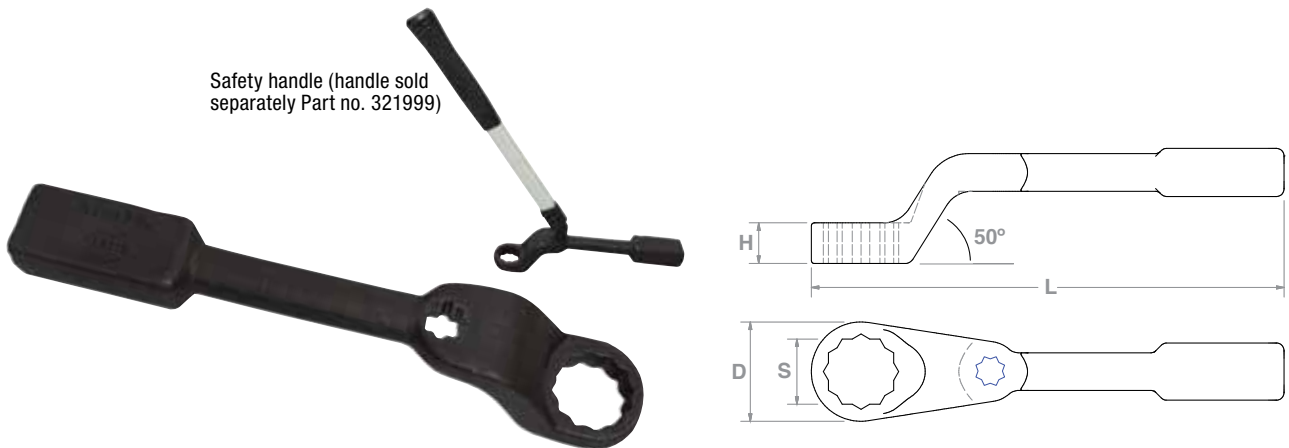

Part No.	Size (S)	Depth (D)	Length (L)	Height (H)	Weight
SWRM24/CS	24mm	52mm	304mm	21mm	1970g
SWRM27/CS	27mm	52mm	304mm	21mm	1970g
SWRM30/CS	30mm	52mm	304mm	21mm	1970g
SWRM32/CS	32mm	52mm	304mm	21mm	1970g
SWRM36/CS	36mm	52mm	304mm	21mm	1970g
SWRM41/CS	41mm	66mm	314mm	27mm	2300g
SWRM46/CS	46mm	66mm	314mm	27mm	2300g
SWRM50/CS	50mm	78mm	378mm	32mm	3940g
SWRM55/CS	55mm	78mm	378mm	32mm	3940g
SWRM60/CS	60mm	110mm	406mm	42mm	5920g
SWRM65/CS	65mm	110mm	406mm	42mm	5920g
SWRM70/CS	70mm	110mm	406mm	42mm	5920g
SWRM75/CS	75mm	110mm	406mm	42mm	5920g

321999

Slogging Wrench Handle

- Overall length: 400mm
- 1/2" square drive
- One size suits all



PODGERS & SLOGGERS

Open Jaw Slogging Wrenches Metric

- Suitable for various applications such as ship maintenance, mining, piping and industrial applications where extra force is required to tighten or loosen large nuts, bolts and other fasteners
- Manufactured from drop forged, hardened and tempered chrome vanadium steel with powder coated finish
- The shock of the striking impact is useful in cracking stubborn fasteners or tightening newly applied fasteners

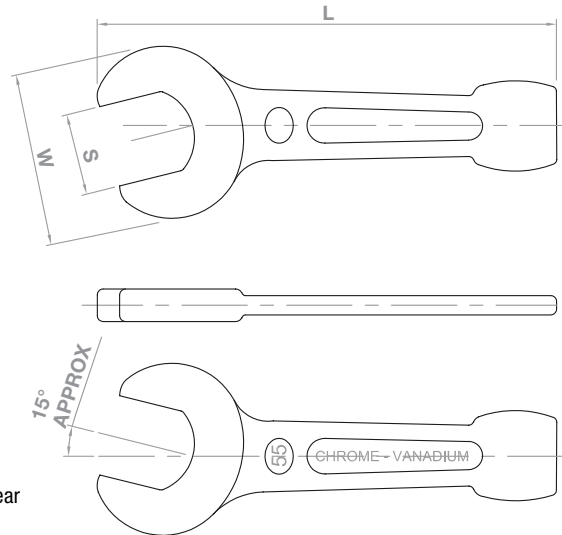

When using any slogging wrench always wear protective eye and head wear

Part No.	Size (S)	Width (W)	Length (L)	Weight
SWOM22	22mm	52mm	160mm	315g
SWOM24	24mm	56mm	170mm	380g
SWOM27	27mm	57mm	180mm	380g
SWOM30	30mm	65mm	185mm	450g
SWOM32	32mm	65mm	190mm	485g
SWOM34	34mm	65mm	190mm	485g
SWOM36	36mm	73mm	220mm	690g
SWOM38	38mm	73mm	220mm	700g
SWOM41	41mm	84mm	235mm	820g
SWOM42	42mm	84mm	235mm	820g
SWOM46	46mm	96mm	255mm	1130g
SWOM50	50mm	103mm	275mm	1450g
SWOM55	55mm	114mm	300mm	1860g
SWOM60	60mm	126mm	320mm	2250g
SWOM65	65mm	135mm	340mm	2925g
SWOM70	70mm	149mm	375mm	4400g
SWOM75	75mm	151mm	375mm	4270g
SWOM80	80mm	171mm	408mm	5670g
SWOM85	85mm	171mm	408mm	5670g
SWOM90	90mm	192mm	438mm	7630g
SWOM95	95mm	192mm	438mm	7100g
SWOM100	100mm	211mm	478mm	9250g
SWOM105	105mm	211mm	478mm	9250g
SWOM110	110mm	231mm	502mm	11750g
SWOM115	115mm	231mm	502mm	12300g
SWOM120	120mm	251mm	502mm	12615g